

SURFACE MOUNT GPP
TRANSIENT VOLTAGE SUPPRESSOR
1500 WATT PEAK POWER 5.0 WATTS STEADY STATE

FEATURES

- * Plastic package has underwriters laboratory
- * Glass passivated chip construction
- * 1500 watt surge capability at 1ms
- * Excellent clamping capability
- * Low zener impedance
- * Fast response time

Ratings at 25 °C ambient temperature unless otherwise specified.

MAXIMUM RATINGS AND ELECTRICAL CHARACTERISTICS

Ratings at 25 °C ambient temperature unless otherwise specified.



DO-214AB

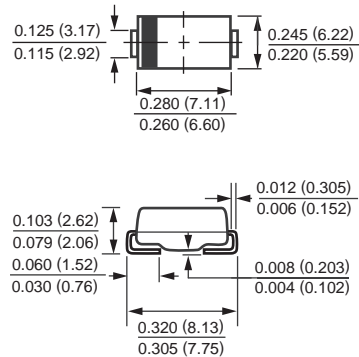

DEVICES FOR BIPOLAR APPLICATIONS

For Bidirectional use C or CA suffix for types TFMCJ5.0 thru TFMCJ170

Electrical characteristics apply in both direction

MAXIMUM RATINGS (At TA = 25°C unless otherwise noted)

RATINGS	SYMBOL	VALUE	UNITS
Peak Power Dissipation with a 10/1000uS (Note 1,2, Fig.1)	PPPM	Minimum 1500	Watts
Peak Pulse Current with a 10/1000uS waveform (Note 1, Fig.3)	IPPM	SEE TABLE 1	Amps
Steady State Power Dissipation at TL = 75°C (Note 2)	PM(AV)	5.0	Watts
Peak Forward Surge Current 8.3mS single half sine-wave superimposed on rated load (JEDEC method) (Note 2,3) unidirectional only	IFSM	200	Amps
Maximum Instantaneous Forward Voltage at 100A for unidirectional only (Note 3,4)	VF	SEE NOTE 3,4	Volts
Operating and Storage Temperature Range	TJ, TSTG	-55 to + 150	°C
Thermal Resistance Junction to Ambient Air	R θJA	75	°C/W
Thermal Resistance Junction to Leads	R θJL	15	°C/W

NOTES :

1. Non-repetitive current pulse, per Fig.3 and derated above TA = 25°C per Fig.2.
2. Mounted on 0.31 X 0.31" (8.0 X 8.0mm) copper pad to each terminal.
3. Lead temperature at TL = 25°C
4. Measured on 8.3mS single half sine-wave duty cycle = 4 pules per minute maximum.
5. VF = 3.5V on TFMCJ-5.0 thru TFMCJ-90 devices and VF = 5.0V on TFMCJ-100 thru TFMCJ-170 devices.
- 6"Fully ROHS compliant", "100% Sn plating(Pb-free).

RATING AND CHARACTERISTIC CURVES (TFMCJ5.0 THRU TFMCJ170CA)

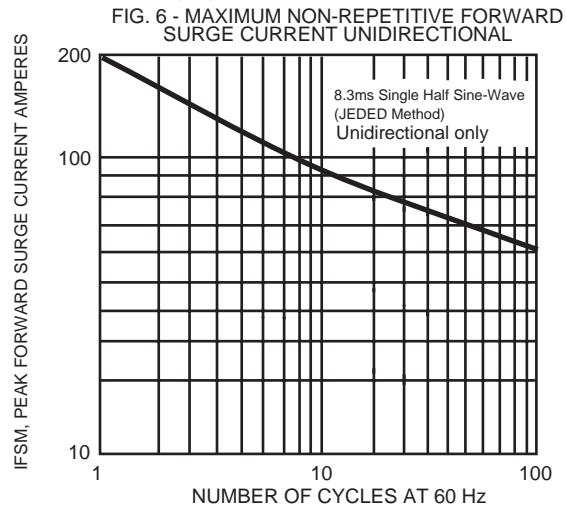
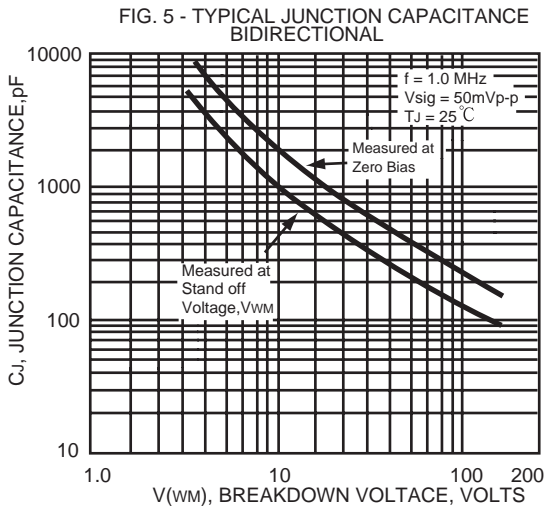
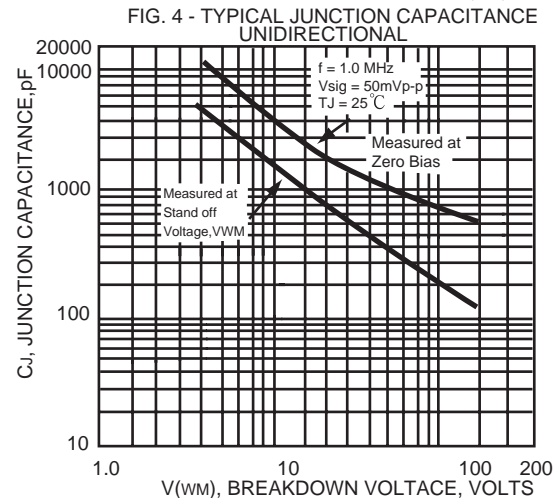
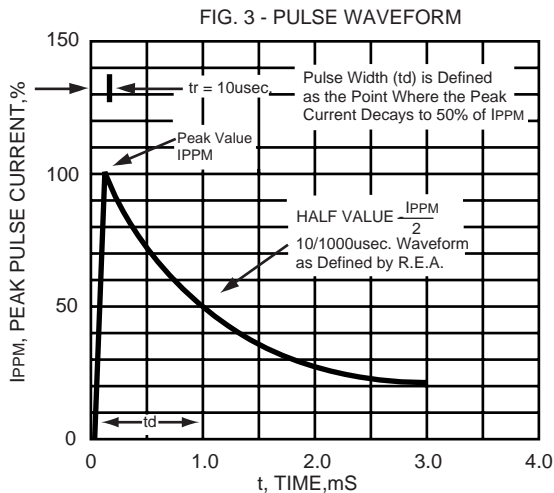
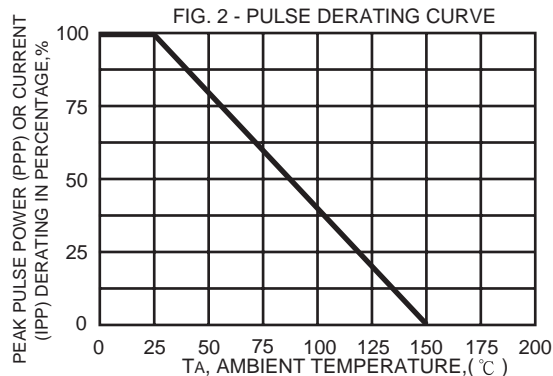
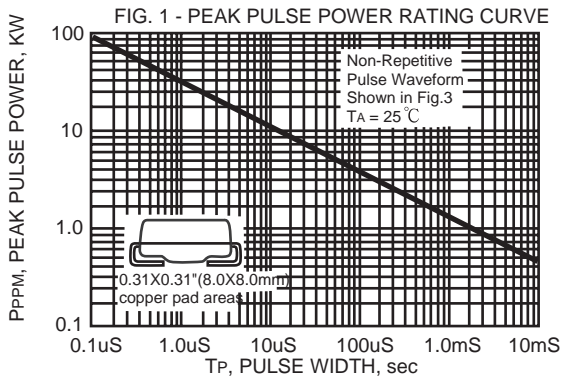

TRANSIENT VOLTAGE SUPPRESSORS

1500W SERIES TVS DIODES/DO-214AB (CASE 4) 1500W

Rectron Industry No.	Rectron House No.	Breakdown Voltage			Reverse Stand off Voltage VWM (Volts)	Maximum Reverse Leakage at VWM ID(uA)	Maximum Peak Pulse Current IPPM (Amps)	Maximum Clamping Voltage at IPPM VC (Volts)
		VBR (Volts)		@IT (mA)				
		MIN.	MAX.					
SMCJ5.0	TFMCJ5.0	6.40	7.82	10	5.0	1000	156.3	9.6
SMCJ5.0A	TFMCJ5.0A	6.40	7.07	10	5.0	1000	163.0	9.2
SMCJ6.0	TFMCJ6.0	6.67	8.15	10	6.0	1000	131.6	11.4
SMCJ6.0A	TFMCJ6.0A	6.67	7.37	10	6.0	1000	145.6	10.3
SMCJ6.5	TFMCJ6.5	7.22	8.82	10	6.5	500.0	122.0	12.3
SMCJ6.5A	TFMCJ6.5A	7.22	7.98	10	6.5	500.0	133.9	11.2
SMCJ7.0	TFMCJ7.0	7.78	9.51	10	7.0	200.0	112.8	13.3
SMCJ7.0A	TFMCJ7.0A	7.78	8.60	10	7.0	200.0	125.0	12.0
SMCJ7.5	TFMCJ7.5	8.33	10.2	10	7.5	100.0	104.9	14.3
SMCJ7.5A	TFMCJ7.5A	8.33	9.21	1.0	7.5	100.0	116.3	12.9
SMCJ8.0	TFMCJ8.0	8.89	10.9	1.0	8.0	50.0	100.0	15.0
SMCJ8.0A	TFMCJ8.0A	8.89	9.83	1.0	8.0	50.0	110.3	13.6
SMCJ8.5	TFMCJ8.5	9.44	11.5	1.0	8.5	25	94.3	15.9
SMCJ8.5A	TFMCJ8.5A	9.44	10.4	1.0	8.5	25	104.2	14.4
SMCJ9.0	TFMCJ9.0	10.0	12.2	1.0	9.0	10	88.8	16.9
SMCJ9.0A	TFMCJ9.0A	10.0	11.1	1.0	9.0	10	97.4	15.4
SMCJ10	TFMCJ10	11.1	13.6	1.0	10.0	5.0	79.8	18.8
SMCJ10A	TFMCJ10A	11.1	12.3	1.0	10.0	5.0	88.2	17.0
SMCJ11	TFMCJ11	12.2	14.9	1.0	11.0	5.0	74.6	20.1
SMCJ11A	TFMCJ11A	12.2	13.5	1.0	11.0	5.0	82.4	18.2
SMCJ12	TFMCJ12	13.3	16.3	1.0	12.0	5.0	68.2	22.0
SMCJ12A	TFMCJ12A	13.3	14.7	1.0	12.0	5.0	75.4	19.9
SMCJ13	TFMCJ13	14.4	17.6	1.0	13.0	5.0	63.0	23.8
SMCJ13A	TFMCJ13A	14.4	15.9	1.0	13.0	5.0	69.8	21.5
SMCJ14	TFMCJ14	15.6	19.1	1.0	14.0	5.0	58.1	25.8
SMCJ14A	TFMCJ14A	15.6	17.2	1.0	14.0	5.0	64.7	23.2
SMCJ15	TFMCJ15	16.7	20.4	1.0	15.0	5.0	55.8	26.9
SMCJ15A	TFMCJ15A	16.7	18.5	1.0	15.0	5.0	61.5	24.4
SMCJ16	TFMCJ16	17.8	21.8	1.0	16.0	5.0	52.1	28.8
SMCJ16A	TFMCJ16A	17.8	19.7	1.0	16.0	5.0	57.7	26.0
SMCJ17	TFMCJ17	18.9	23.1	1.0	17.0	5.0	49.2	30.5
SMCJ17A	TFMCJ17A	18.9	20.9	1.0	17.0	5.0	54.3	27.6
SMCJ18	TFMCJ18	20.0	24.4	1.0	18.0	5.0	46.6	32.2
SMCJ18A	TFMCJ18A	20.0	22.1	1.0	18.0	5.0	51.4	29.2
SMCJ20	TFMCJ20	22.2	27.1	1.0	20.0	5.0	41.9	35.8
SMCJ20A	TFMCJ20A	22.2	24.5	1.0	20.0	5.0	46.3	32.4
SMCJ22	TFMCJ22	24.4	29.8	1.0	22.0	5.0	38.1	39.4
SMCJ22A	TFMCJ22A	24.4	26.9	1.0	22.0	5.0	42.3	35.5
SMCJ24	TFMCJ24	26.7	32.6	1.0	24.0	5.0	34.9	43.0
SMCJ24A	TFMCJ24A	26.7	29.5	1.0	24.0	5.0	38.6	38.9
SMCJ26	TFMCJ26	28.9	35.3	1.0	26.0	5.0	32.2	46.6
SMCJ26A	TFMCJ26A	28.9	31.9	1.0	26.0	5.0	35.6	42.1
SMCJ28	TFMCJ28	31.1	38.0	1.0	28.0	5.0	30.0	50.1
SMCJ28A	TFMCJ28A	31.1	34.4	1.0	28.0	5.0	33.0	45.4
SMCJ30	TFMCJ30	33.3	40.7	1.0	30.0	5.0	28.0	53.5
SMCJ30A	TFMCJ30A	33.3	36.8	1.0	30.0	5.0	31.0	48.4
SMCJ33	TFMCJ33	36.7	44.9	1.0	33.0	5.0	25.4	59.0
SMCJ33A	TFMCJ33A	36.7	40.6	1.0	33.0	5.0	28.1	53.3
SMCJ36	TFMCJ36	40.0	48.9	1.0	36.0	5.0	23.3	64.3
SMCJ36A	TFMCJ36A	40.0	44.2	1.0	36.0	5.0	25.8	58.1

TRANSIENT VOLTAGE SUPPRESSORS

1500W SERIES TVS DIODES/DO-214AB (CASE 4) 1500W

Rectron Industry No.	Rectron House No.	Breakdown Voltage			Reverse Stand off Voltage V _{WM} (Volts)	Maximum Reverse Leakage at V _{WM} I _D (uA)	Maximum Peak Pulse Current IPPM (Amps)	Maximum Clamping Voltage at IPPM V _C (Volts)
		V _{BR} (Volts)		@I _T (mA)				
		MIN.	MAX.					
SMCJ40	TFMCJ40	44.4	54.3	1.0	40	5.0	21.0	71.4
SMCJ40A	TFMCJ40A	44.4	49.1	1.0	40	5.0	23.3	64.5
SMCJ43	TFMCJ43	47.8	58.4	1.0	43	5.0	19.6	76.7
SMCJ43A	TFMCJ43A	47.8	52.8	1.0	43	5.0	21.6	69.4
SMCJ45	TFMCJ45	50.0	61.1	1.0	45	5.0	18.7	80.3
SMCJ45A	TFMCJ45A	50.0	55.3	1.0	45	5.0	20.6	72.7
SMCJ48	TFMCJ48	53.3	65.1	1.0	48	5.0	17.5	85.5
SMCJ48A	TFMCJ48A	53.3	58.9	1.0	48	5.0	19.4	77.4
SMCJ51	TFMCJ51	56.7	69.3	1.0	51	5.0	16.5	91.1
SMCJ51A	TFMCJ51A	56.7	62.7	1.0	51	5.0	18.2	82.4
SMCJ54	TFMCJ54	60.0	73.3	1.0	54	5.0	15.6	96.3
SMCJ54A	TFMCJ54A	60.0	66.3	1.0	54	5.0	17.2	87.1
SMCJ58	TFMCJ58	64.4	78.7	1.0	58	5.0	14.6	103
SMCJ58A	TFMCJ58A	64.4	71.2	1.0	58	5.0	16.0	93
SMCJ60	TFMCJ60	66.7	81.5	1.0	60	5.0	14.0	107
SMCJ60A	TFMCJ60A	66.7	73.7	1.0	60	5.0	15.5	96
SMCJ64	TFMCJ64	71.1	86.9	1.0	64	5.0	13.2	114
SMCJ64A	TFMCJ64A	71.1	78.6	1.0	64	5.0	14.6	103
SMCJ70	TFMCJ70	77.8	95.1	1.0	70	5.0	12.0	125
SMCJ70A	TFMCJ70A	77.8	86.0	1.0	70	5.0	13.3	113
SMCJ75	TFMCJ75	83.3	102	1.0	75	5.0	11.2	134
SMCJ75A	TFMCJ75A	83.3	92.1	1.0	75	5.0	12.4	121
SMCJ78	TFMCJ78	86.7	106	1.0	78	5.0	10.8	139
SMCJ78A	TFMCJ78A	86.7	95.8	1.0	78	5.0	11.9	126
SMCJ85	TFMCJ85	94.4	115	1.0	85	5.0	9.9	151
SMCJ85A	TFMCJ85A	94.4	104	1.0	85	5.0	10.9	137
SMCJ90	TFMCJ90	100	122	1.0	90	5.0	9.4	160
SMCJ90A	TFMCJ90A	100	111	1.0	90	5.0	10.3	146
SMCJ100	TFMCJ100	111	136	1.0	100	5.0	8.4	179
SMCJ100A	TFMCJ100A	111	123	1.0	100	5.0	9.3	162
SMCJ110	TFMCJ110	122	149	1.0	110	5.0	7.7	196
SMCJ110A	TFMCJ110A	122	135	1.0	110	5.0	8.5	177
SMCJ120	TFMCJ120	133	163	1.0	120	5.0	7.0	214
SMCJ120A	TFMCJ120A	133	147	1.0	120	5.0	7.8	193
SMCJ130	TFMCJ130	144	176	1.0	130	5.0	6.5	231
SMCJ130A	TFMCJ130A	144	159	1.0	130	5.0	7.2	209
SMCJ150	TFMCJ150	167	204	1.0	150	5.0	5.6	268
SMCJ150A	TFMCJ150A	167	185	1.0	150	5.0	6.2	243
SMCJ160	TFMCJ160	178	218	1.0	160	5.0	5.2	287
SMCJ160A	TFMCJ160A	178	197	1.0	160	5.0	5.8	259
SMCJ170	TFMCJ170	189	231	1.0	170	5.0	4.9	304
SMCJ170A	TFMCJ170A	189	209	1.0	170	5.0	5.5	275

- Notes :
1. V_{BR} measured after I_T applied for 300ms. I_T = square pulse or equivalent.
 2. For bidirectional use C or CA suffixs for all types (ex. SMCJ5.0C, SMCJ170CA) electrical characteristics apply in both directions.
 3. For bidirectional types having V_{WM} of 10 volts and less, the I_D limit is doubled.
 4. All devices UL listed file# E211196.

Mounting Pad Layout

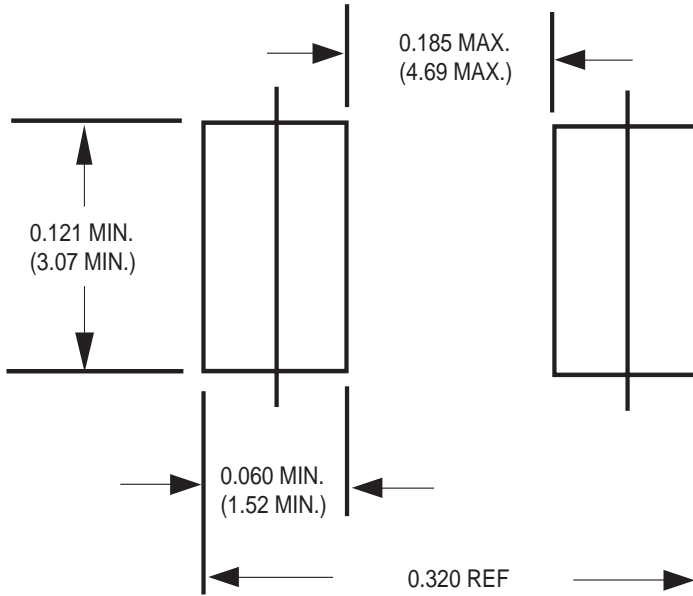

Dimensions in inches and (millimeters)