

**SURFACE MOUNT SCHOTTKY BARRIER RECTIFIER**

**VOLTAGE RANGE 20 to 60 Volts CURRENT 0.5 Ampere**

**FEATURES**

- \* Low power loss, high efficiency
- \* Low leakage
- \* Low forward voltage
- \* High current capability
- \* High speed switching
- \* High surge capability
- \* High reliability

**MECHANICAL DATA**

- \* Epoxy: Device has UL flammability classification 94V-O
- \* Mounting position: Any
- \* Weight: 0.016 gram

**MAXIMUM RATINGS AND ELECTRICAL CHARACTERISTICS**

Ratings at 25 °C ambient temperature unless otherwise specified.  
 Single phase, half wave, 60 Hz, resistive or inductive load.  
 For capacitive load, derate current by 20%.



**SOD-123FL**

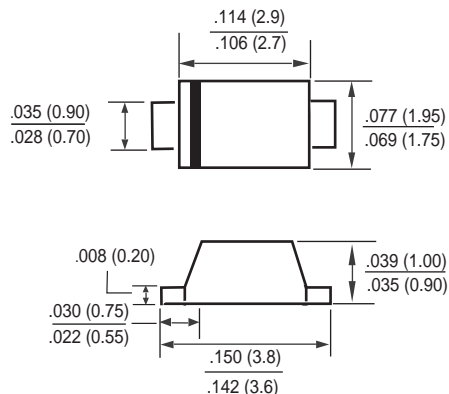

Dimensions in inches and (millimeters)

**MAXIMUM RATINGS** (At TA = 25°C unless otherwise noted)

RATINGS	SYMBOL	05S2L	05S3L	05S4L	05S5L	05S6L	UNITS
Maximum Recurrent Peak Reverse Voltage	VRRM	20	30	40	50	60	Volts
Maximum RMS Voltage	VRMS	14	21	28	35	42	Volts
Maximum DC Blocking Voltage	Vdc	20	30	40	50	60	Volts
Maximum Average Forward Rectified Current .375" (9.5mm) lead length at TA=55°C	IO	0.5					Amps
Peak Forward Surge Current 8.3 ms single half sine-wave superimposed on rated load (JEDEC method)	IFSM	15					Amps
Typical Junction Capacitance (Note 1)	CJ	140					pF
Operating Temperature Range	TJ	-55 to + 150					°C
Storage Temperature Range	TsTG	-55 to + 150					°C

**ELECTRICAL CHARACTERISTICS** (At TA = 25°C unless otherwise noted)

CHARACTERISTICS	SYMBOL	05S2L	05S3L	05S4L	05S5L	05S6L	UNITS
Maximum Instantaneous Forward Voltage at 0.5A DC	VF	.55			.70		Volts
Maximum Average Reverse Current at Rated DC Blocking Voltage	IR	1.0					mAmps
							10

NOTES : 1. Measured at 1 MHz and applied reverse voltage of 4.0 volts.

2. "Fully ROHS compliant", "100% Sn plating (Pb-free)".

# RATING AND CHARACTERISTIC CURVES ( 05S2L THRU 05S6L )

FIG. 1 - TYPICAL FORWARD CURRENT DERATING CURVE

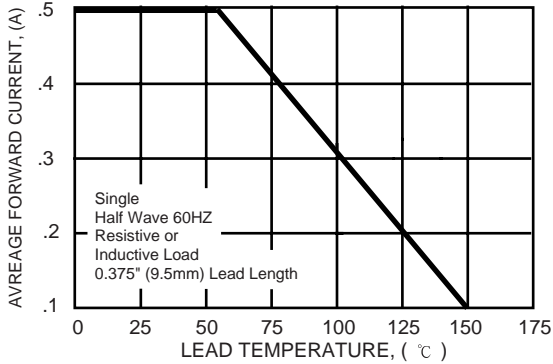

FIG. 2 - TYPICAL INSTANTANEOUS FORWARD CHARACTERISTICS

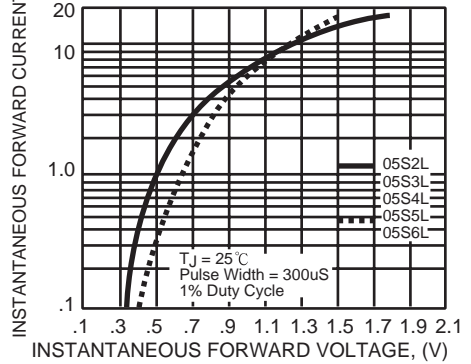

FIG. 3A - TYPICAL REVERSE CHARACTERISTICS

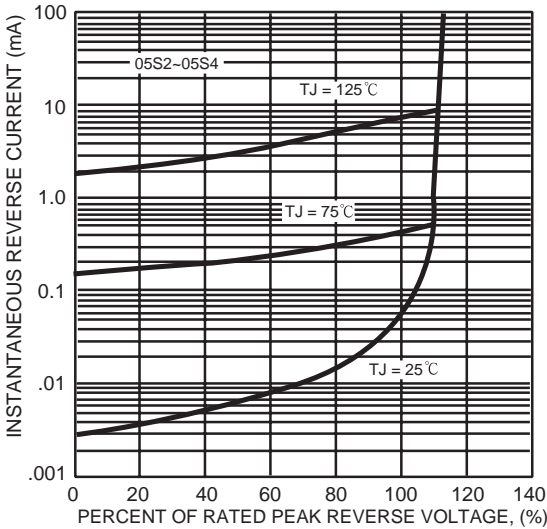

FIG. 3 - TYPICAL REVERSE CHARACTERISTICS

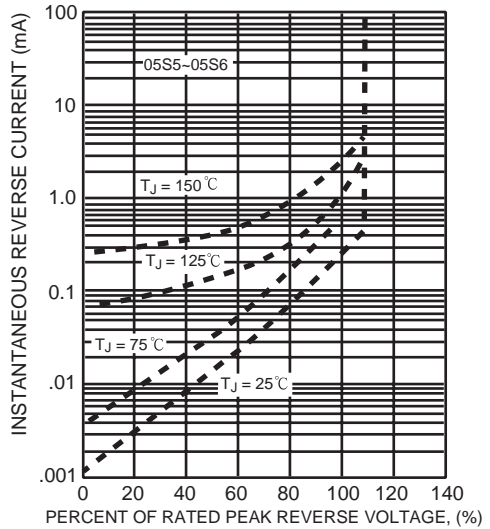

FIG. 4 - TYPICAL JUNCTION CAPACITANCE

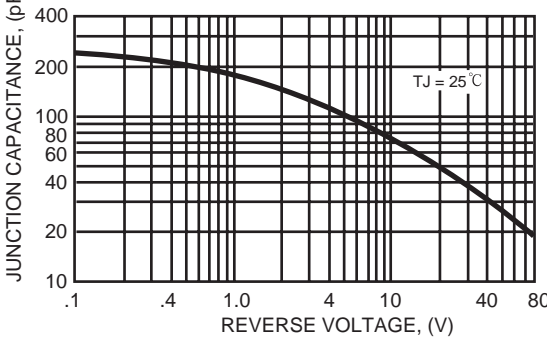
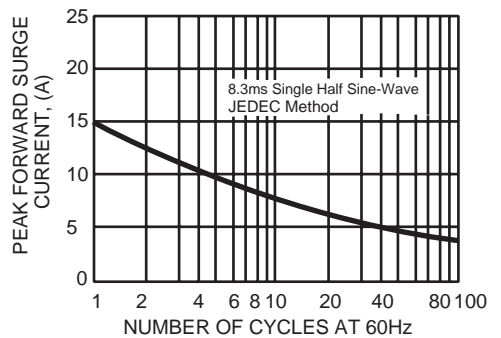
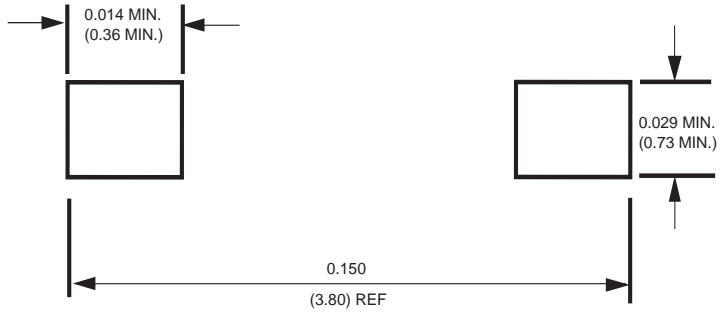

FIG. 5 - MAXIMUM NON-REPETITIVE FORWARD SURGE CURRENT



## Mounting Pad Layout



Dimensions in inches and (millimeters)