

SURFACE MOUNT SCHOTTKY BARRIER RECTIFIER

VOLTAGE RANGE 20 to 60 Volts CURRENT 0.5 Ampere

FEATURES

- * Low power loss, high efficiency
- * Low leakage
- * Low forward voltage
- * High current capability
- * High speed switching
- * High surge capability
- * High reliability

MECHANICAL DATA

- * Epoxy: Device has UL flammability classification 94V-O
- * Mounting position: Any
- * Weight: 0.016 gram

MAXIMUM RATINGS AND ELECTRICAL CHARACTERISTICS

Ratings at 25 °C ambient temperature unless otherwise specified.
 Single phase, half wave, 60 Hz, resistive or inductive load.
 For capacitive load, derate current by 20%.

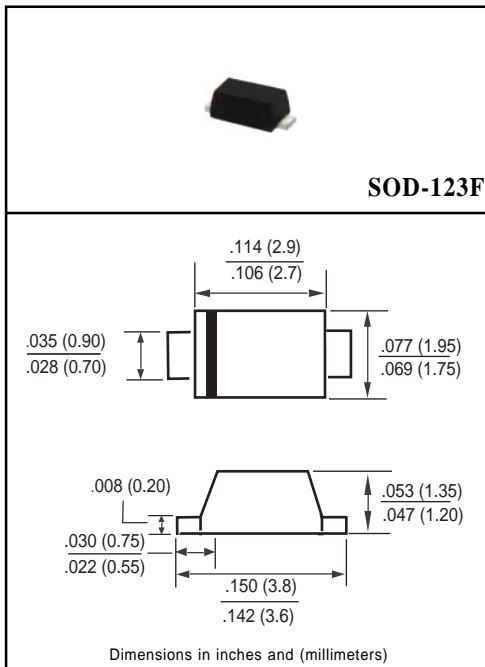

MAXIMUM RATINGS (At TA = 25°C unless otherwise noted)

RATINGS	SYMBOL	05S2	05S3	05S4	05S5	05S6	UNITS
Maximum Recurrent Peak Reverse Voltage	VRRM	20	30	40	50	60	Volts
Maximum RMS Voltage	VRMS	14	21	28	35	42	Volts
Maximum DC Blocking Voltage	Vbc	20	30	40	50	60	Volts
Maximum Average Forward Rectified Current .375" (9.5mm) lead length at TA=55°C	IO	0.5					Amps
Peak Forward Surge Current 8.3 ms single half sine-wave superimposed on rated load (JEDEC method)	IFSM	15					Amps
Typical Junction Capacitance (Note 1)	CJ	140					pF
Operating Temperature Range	TJ	-55 to + 150					°C
Storage Temperature Range	TsTG	-55 to + 150					°C

ELECTRICAL CHARACTERISTICS (At TA = 25°C unless otherwise noted)

CHARACTERISTICS	SYMBOL	05S2	05S3	05S4	05S5	05S6	UNITS
Maximum Instantaneous Forward Voltage at 0.5A DC	VF	.55			.70		Volts
Maximum Average Reverse Current at Rated DC Blocking Voltage	IR	1.0					mAmps
							10

NOTES : 1. Measured at 1 MHz and applied reverse voltage of 4.0 volts.

2. "Fully ROHS compliant", "100% Sn plating (Pb-free)".

RATING AND CHARACTERISTIC CURVES (05S2 THRU 05S6)

FIG. 1 - TYPICAL FORWARD CURRENT DERATING CURVE

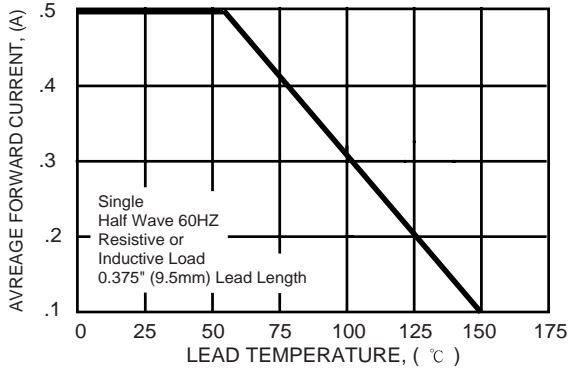

FIG. 2 - TYPICAL INSTANTANEOUS FORWARD CHARACTERISTICS

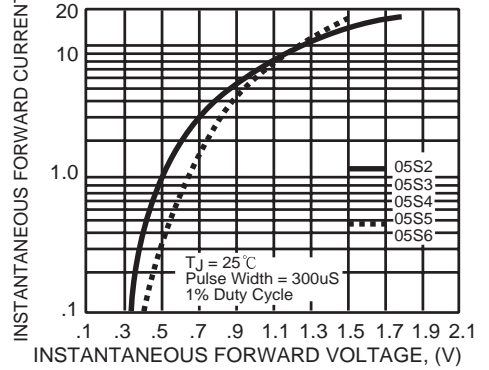

FIG. 3A - TYPICAL REVERSE CHARACTERISTICS

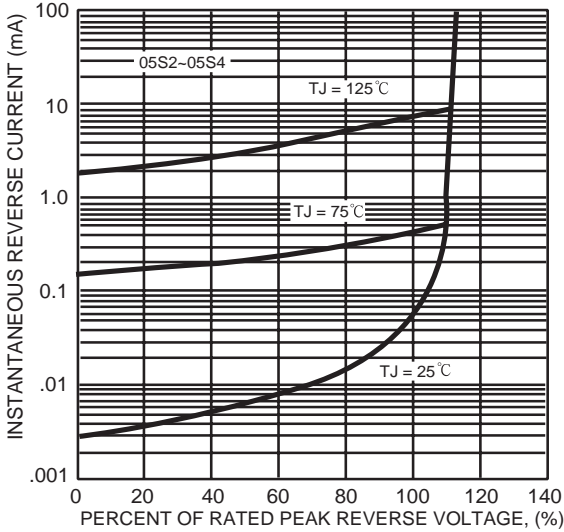

FIG. 3 - TYPICAL REVERSE CHARACTERISTICS

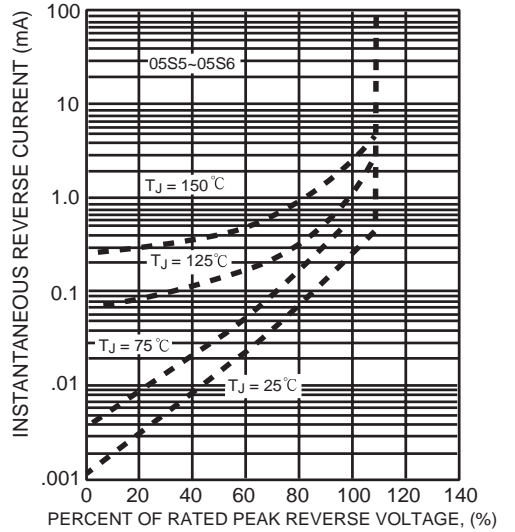

FIG. 4 - TYPICAL JUNCTION CAPACITANCE

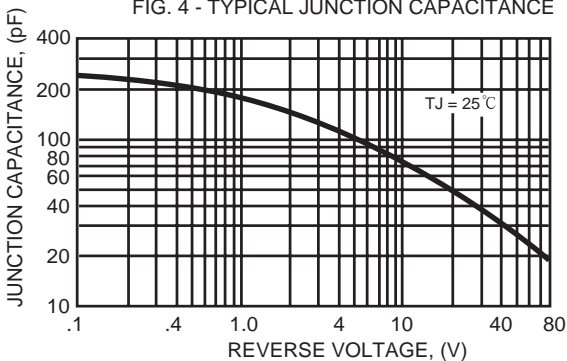
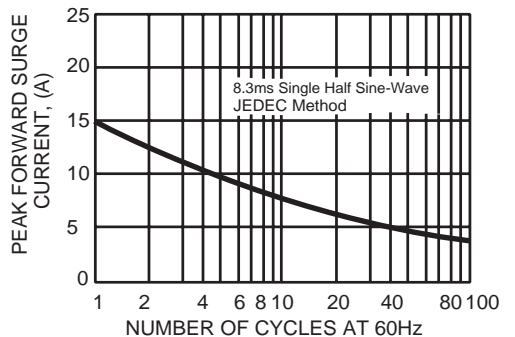
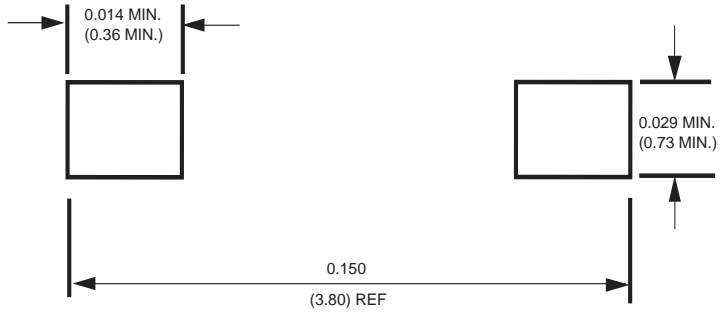

FIG. 5 - MAXIMUM NON-REPETITIVE FORWARD SURGE CURRENT



Mounting Pad Layout



Dimensions in inches and (millimeters)